

Dimensioni e tipologia di "segnaletica"

SEGNALETICA VERTICALE (fuori scala)

Tabelle segnavia



Tabella località



Tabelle tematiche:

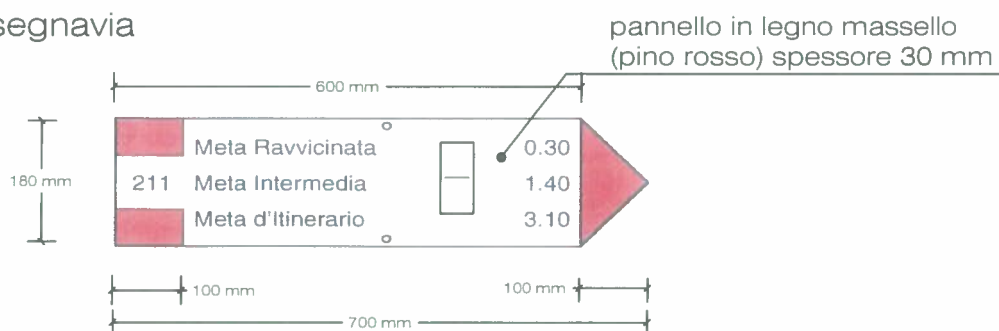

Tabella "Naturalità"

pannello di alluminio in "Dibond"
colore verde spessore 3 mm

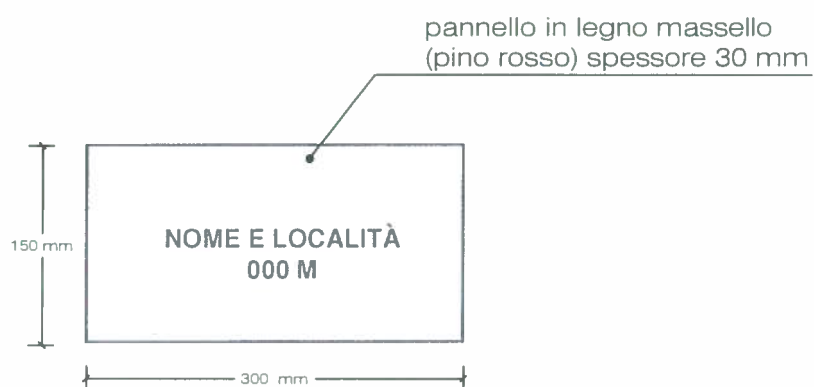

Tabella "Segni dell'uomo"

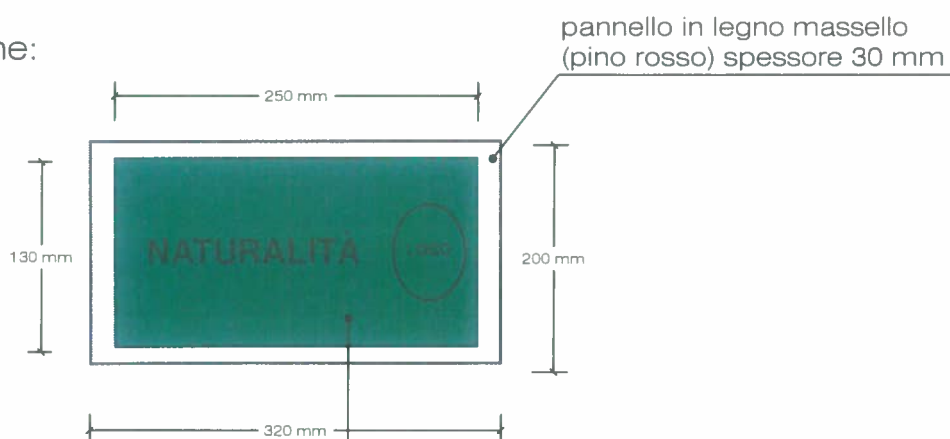

Tabella "Produzione tipica e agricoltura"

Tabelle di fruizione:

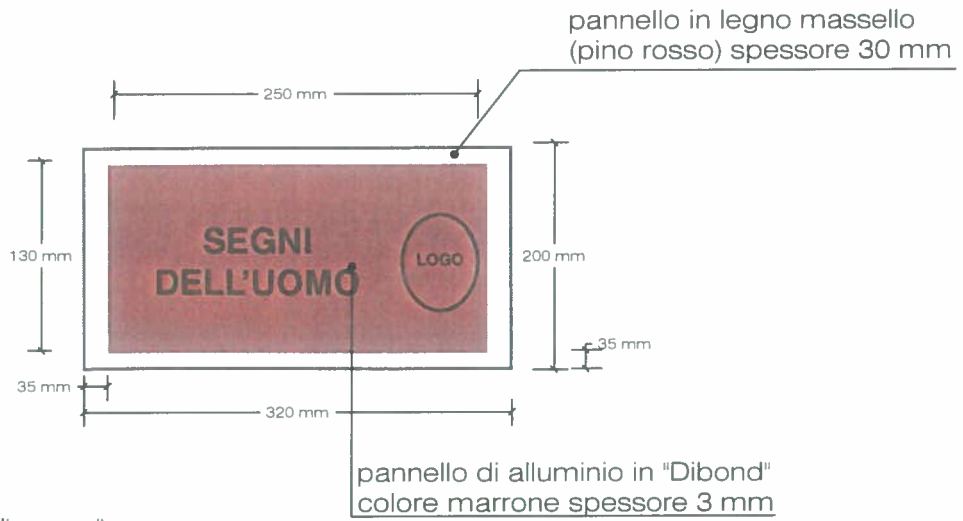

Tabella "Moutain Bike"

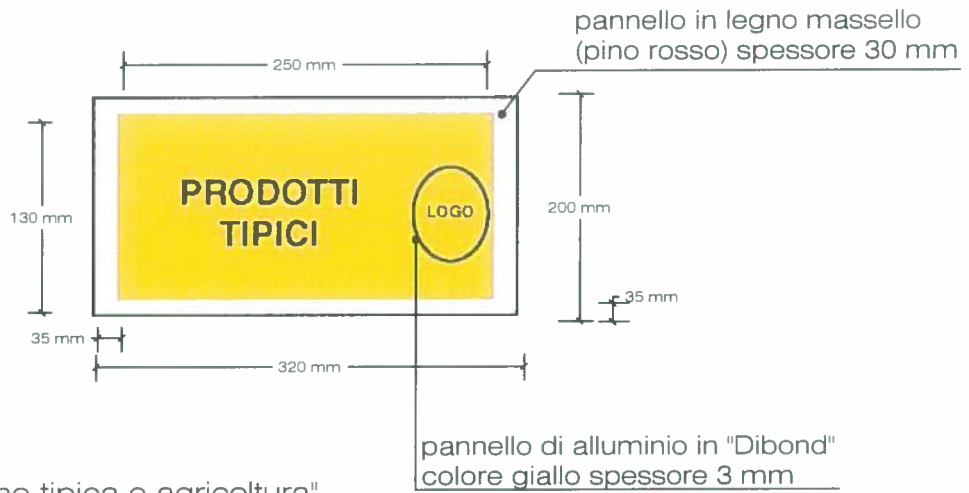

Tabella "Via ferrata"

pannello di alluminio in "Dibond"
colore rosso spessore 3 mm



pannello in legno massello
(pino rosso) spessore 25-30 mm

pannello di alluminio in "Dibond"
colore bianco spessore 3 mm

Tabella "Escursionisti Esperti"

Tabellone o pannello d'insieme

PROSPETTO FRONTALE

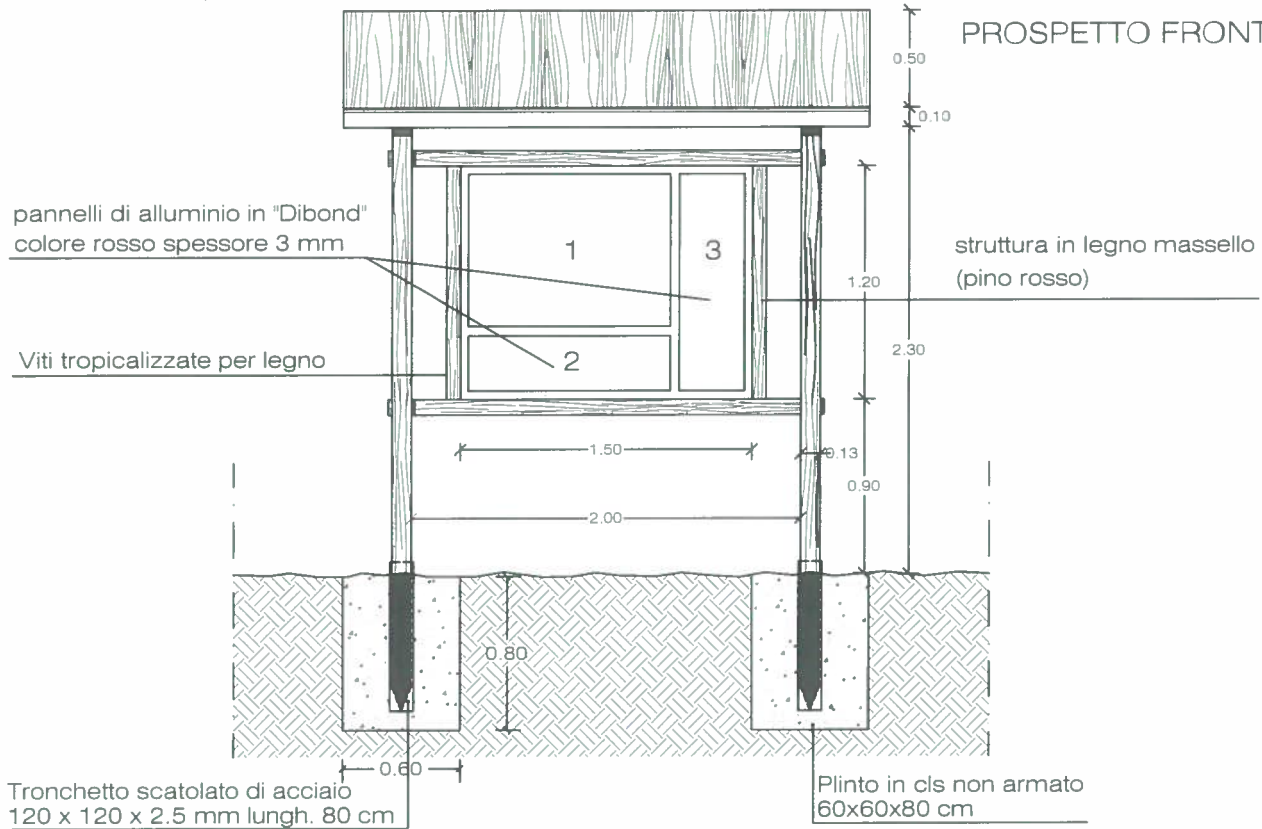

copertura in legno di pino rosso



Tabella o pannello localizzato

PROSPETTO FRONTALE



SEGNALETICA ORIZZONTALE (fuori scala)

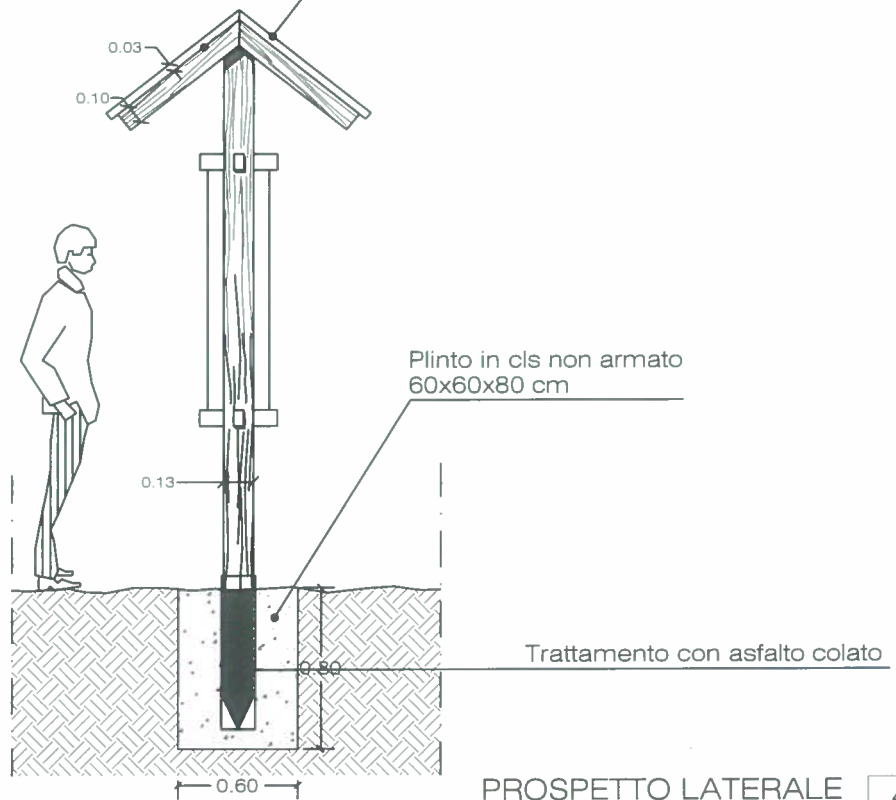
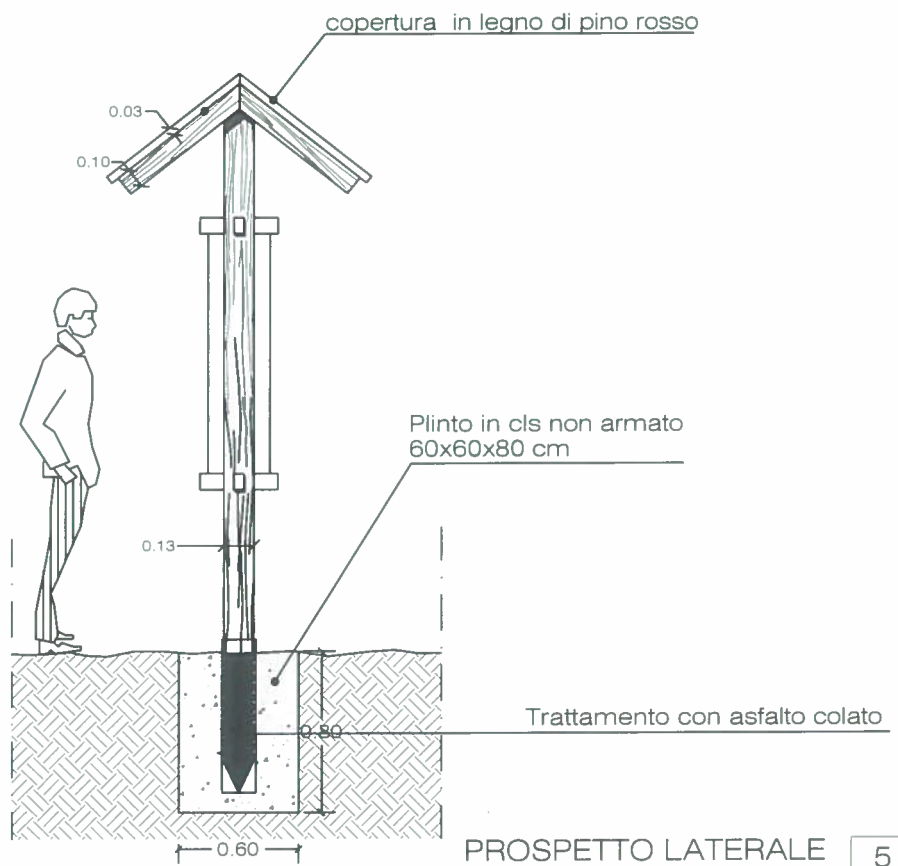
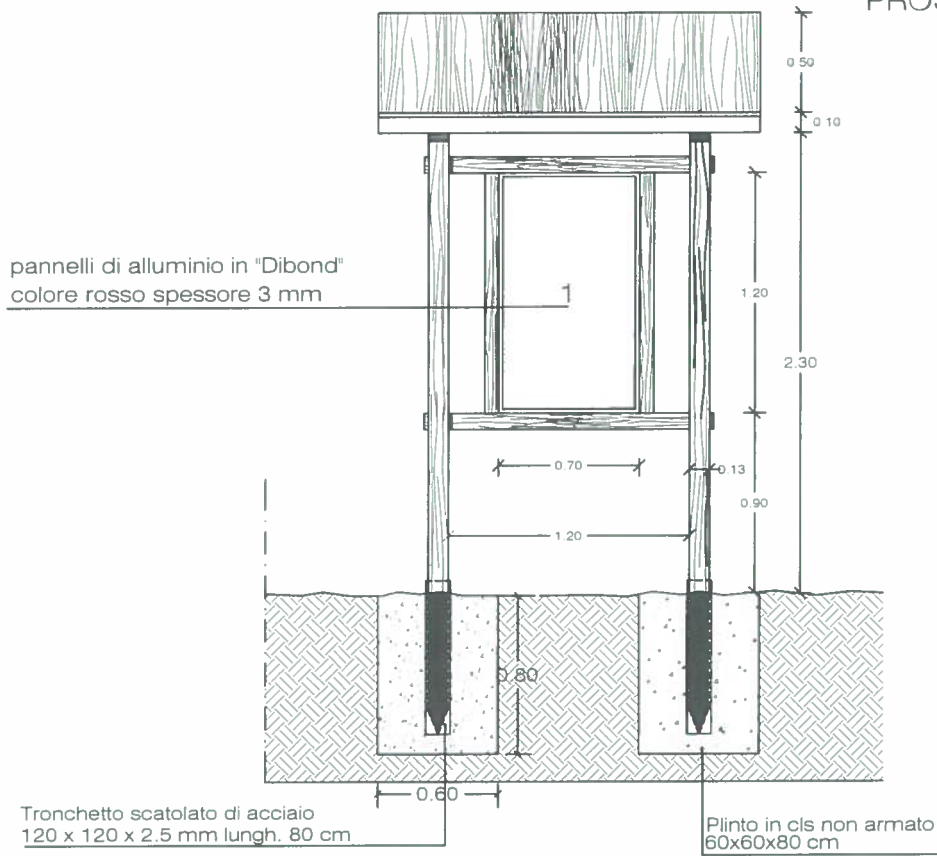
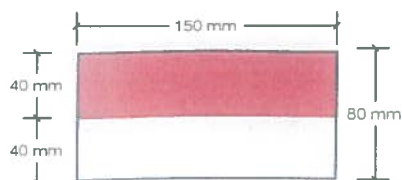

Segnavia semplice di colore bianco-rosso

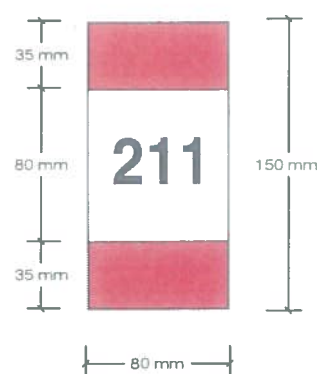
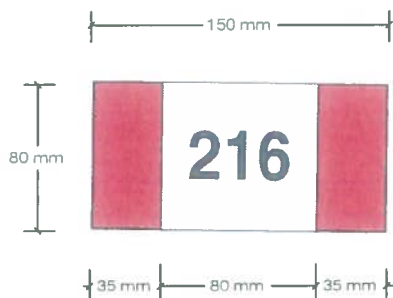

Segnavia a bandiera di colore rosso-bianco-rosso

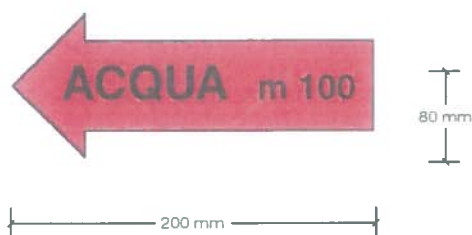

Frecia di colore rosso

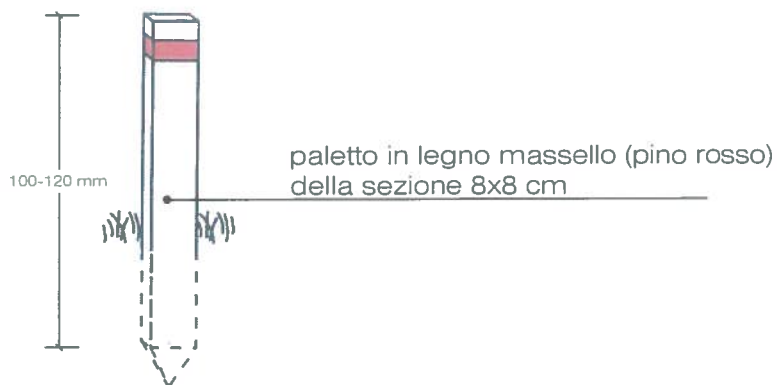

Picchetto segnavia